

30W FIXTURE ASSEMBLY SCHEMATIC
WITH CONCRETE BASE AND PHOTOCELL

KEY	QTY	NAME	DESCRIPTION
A	1	30W BRACKET (W/ PHOTOCELL)	BRACKET ASSEMBLY WITH CONCRETE BASE PER SCHEMATICS
B	1	30W LIGHT	FULLY ASSEMBLED
C	1	LIGHT FUNNEL	ASSEMBLED PER SCHEMATICS
D	2	HEX CAP SCREW	M8 A2 HEX CAP SCREW
E	2	WASHER	5/16" S.S. WASHER
F	2	LOCK WASHER	5/16" S.S. EXTERIOR TOOTH LOCK WASHER

30W FIXTURE ASSEMBLY SCHEMATIC
WITH CONCRETE BASE AND PHOTOCELL

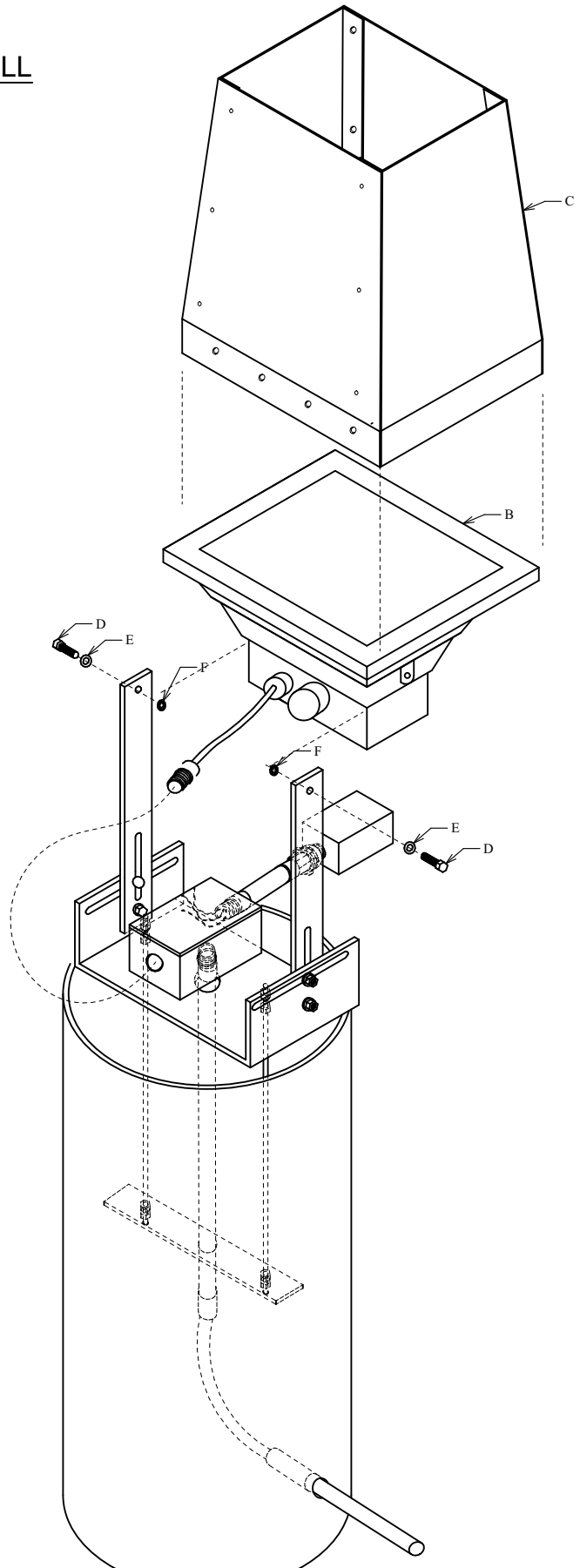

1

EXPLODED AXON VIEW

NOT TO SCALE

02-20-21 Drawn:CLC

A-1

30W FIXTURE ASSEMBLY SCHEMATIC WITH CONCRETE BASE AND PHOTOCELL

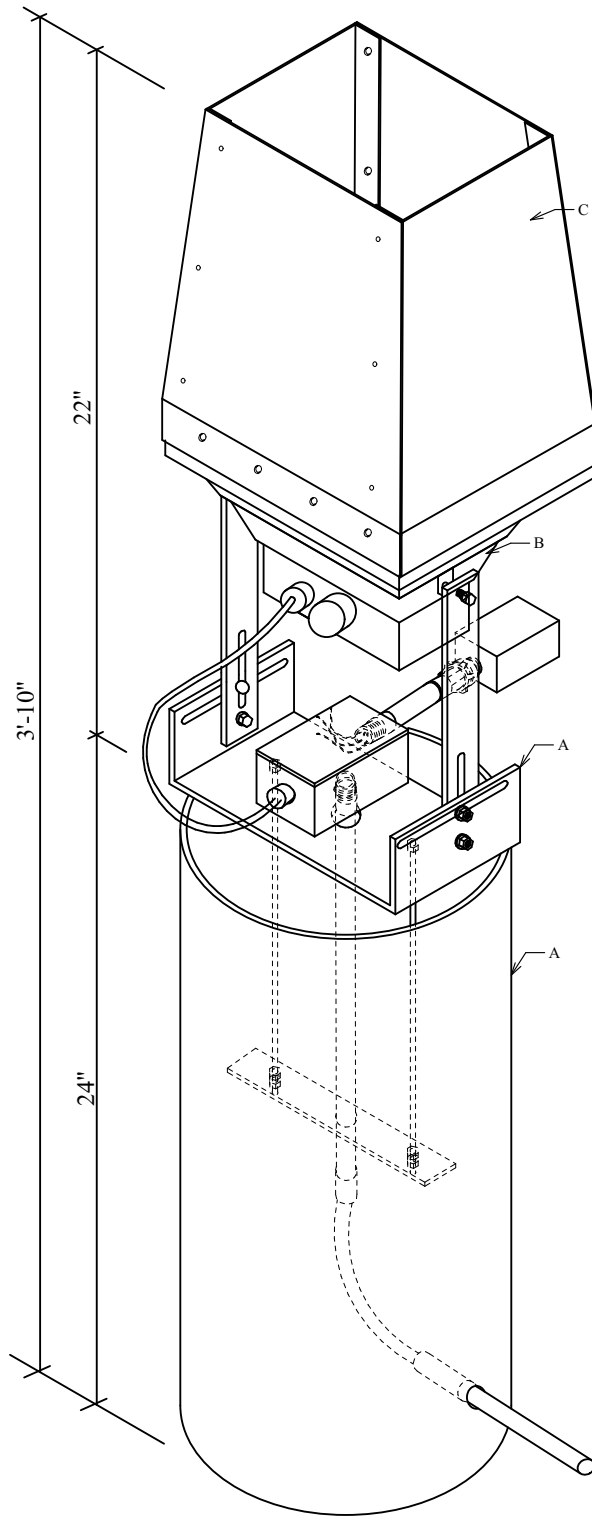

1

AXON VIEW

NOT TO SCALE

02-20-21 Drawn:CLC

A-2

30W FIXTURE ASSEMBLY SCHEMATIC WITH CONCRETE BASE AND PHOTOCELL

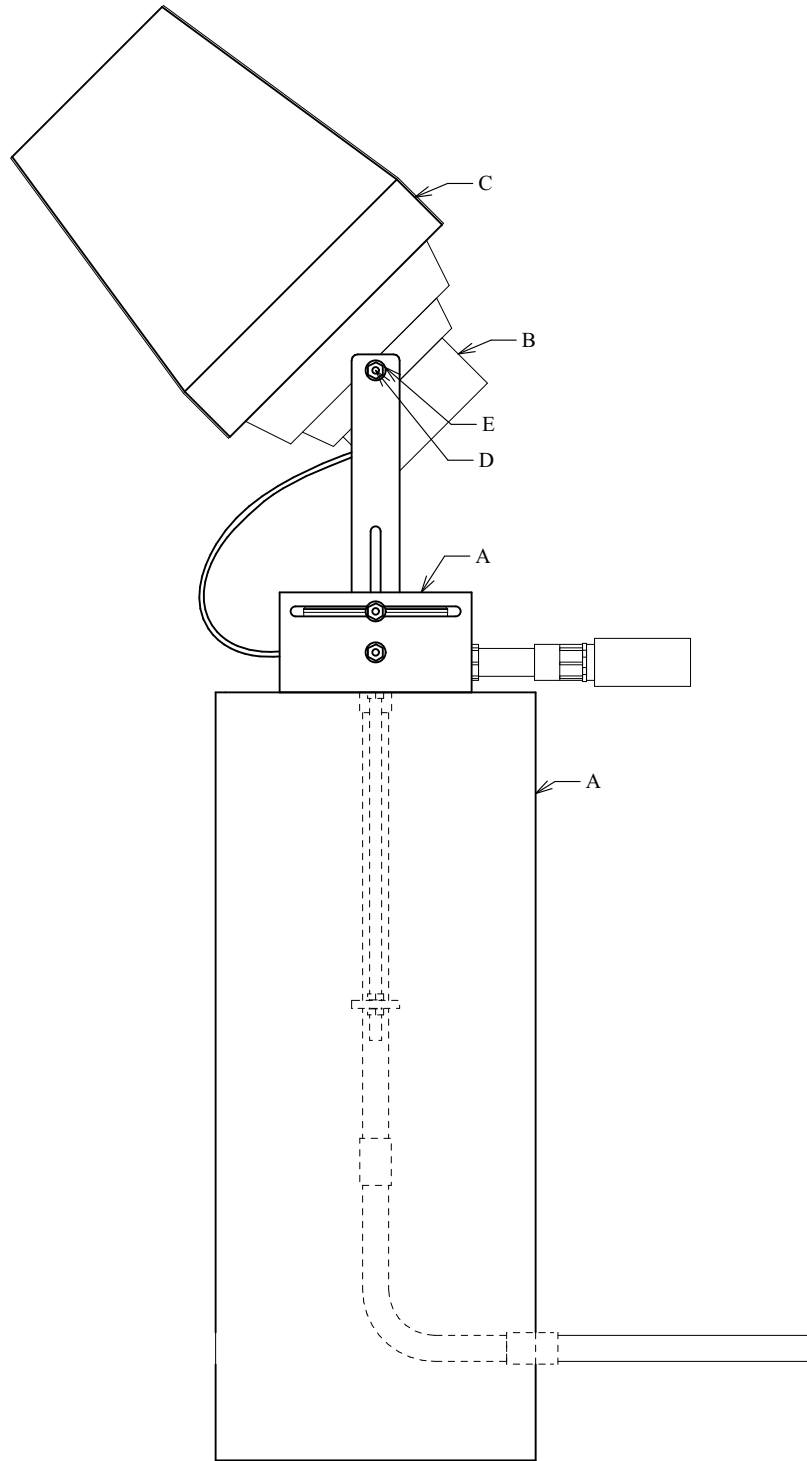

1

SIDE VIEW

SCALE: 1:6

02-20-21 Drawn:CLC

A-3